

WARRANTY

We strive to offer high-quality products, and we also try our best to satisfy each and every customer that orders from us with product or service as needed. We provide 30 days warranty starting from the time you receive the item. Each customer must provide a record of their order such as the order number, or item receipt for any items that are out of the warranty period you may also still receive replacement parts by purchasing them with our company if they are available.

• Cautions



(12)X4

This product is for one person only.



DO NOT use the chair unless all bolts, screws, and knobs are fully tightened.



DO NOT use the chair if any of the parts is missing or damaged.



DO NOT stand on the chair to use as a step stool or ladder.

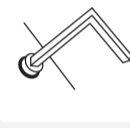

Regularly check if all bolts, screws, and knobs are fully tightened.



Please be careful. Some of the parts are sharp and heavy.



Failure to follow these warnings and instructions could result in serious injury.

• Instructions

NOTICE
Please use the allen key included instead of an electric drill.

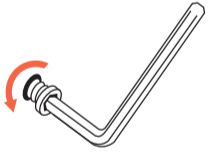

TIPS!

Use the box for an easier assembly.

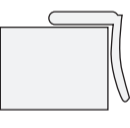

We recommend two people for the assembly process.



STEP 1

Do not fully tighten at this stage. Leave the screws slightly loose to allow for adjustment and alignment in the next step.

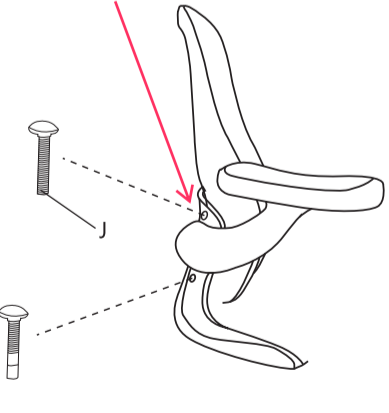

STEP 2

Identify the front of the seat pan. Tighten all screws firmly and completely.

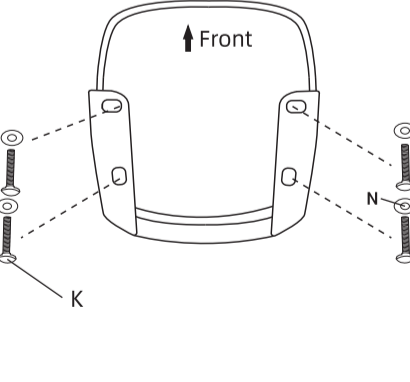

M905 Office Chair







Assembly Instruction

Contents

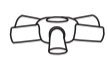
- Instructions
- Cautions

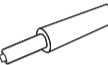

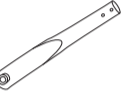
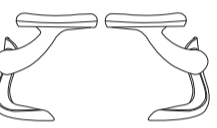
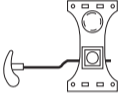
Please make sure all the parts are included.

 Ax1	 Bx1	 Cx1	<table border="1"> <tr><td>Jx4</td><td>M6*30</td></tr> <tr><td>Kx4</td><td>M6*30</td></tr> <tr><td>Lx4</td><td>M6*20</td></tr> <tr><td>Mx1</td><td></td></tr> <tr><td>Nx4</td><td></td></tr> <tr><td>Gx5</td><td>M6*12</td></tr> </table>	Jx4	M6*30	Kx4	M6*30	Lx4	M6*20	Mx1		Nx4		Gx5	M6*12
Jx4	M6*30														
Kx4	M6*30														
Lx4	M6*20														
Mx1															
Nx4															
Gx5	M6*12														
 Dx1	 Ex5	 Fx5													
 Gx1	 Hx1	 Ix1													

Read the instructions carefully.

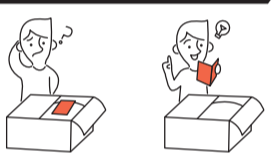

Follow the assembly steps.

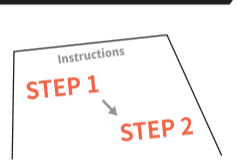

Introduction to tray functions.

Base Knob: Adjusts seat back tilt tension.

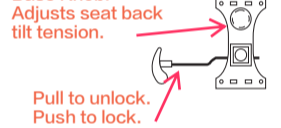

Pull to unlock. Push to lock.

STEP 3

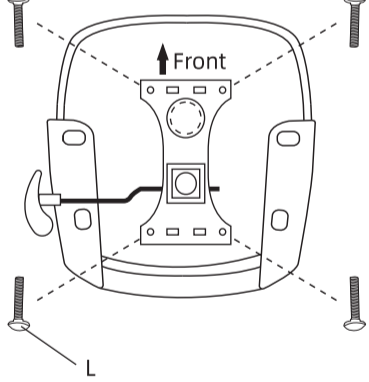

Carefully note the "Front" marking.

STEP 4

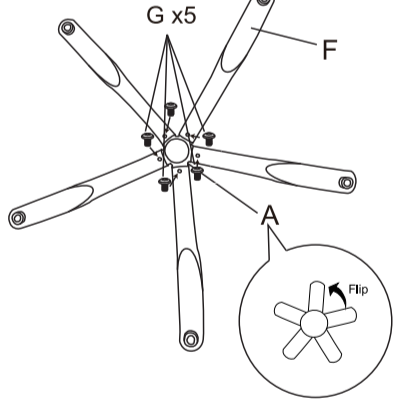

STEP 5

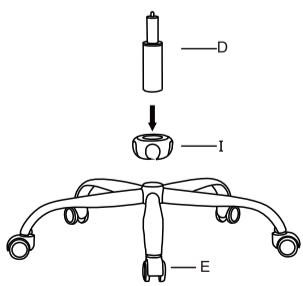

STEP 6

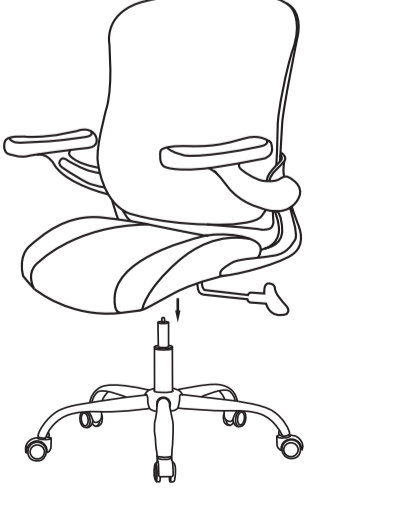

Enjoy your new favorite chair

Our goal is to create a perfect customer experience.

Let us know if you have any feedback.

Your comment motivates us to become a better team.